



**IF PARTS ARE MISSING AND OR DEFECTIVE, IF INSTRUCTIONS ARE NOT CLEAR
OR IF YOU ARE EXPERIENCING PROBLEMS ASSEMBLING OUR PRODUCT.**

**BEFORE YOU RETURN THE PRODUCT TO THE STORE,
PLEASE CALL US TOLL FREE FOR CUSTOMER SERVICE ASSISTANCE**

(888) 777-8250

OR SEND US EMAIL AT

help@spartakent.com

PLEASE HAVE ITEM NUMBER READY, AND A REPRESENTATIVE WILL GLADLY ASSIST YOU

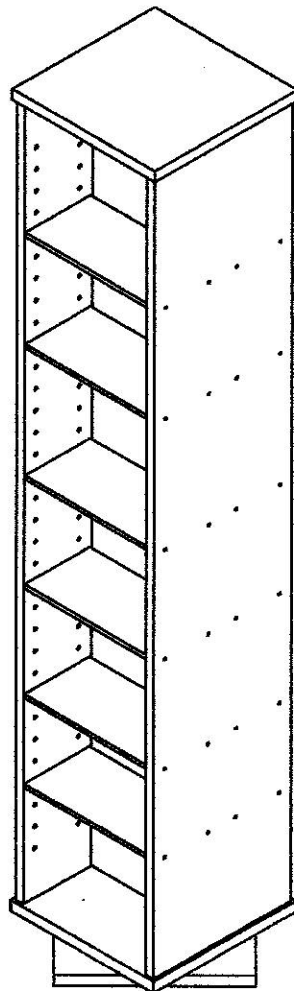



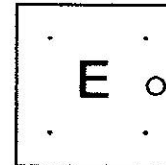
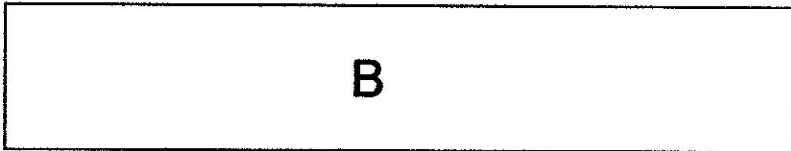
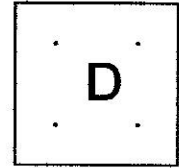
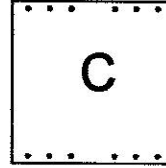
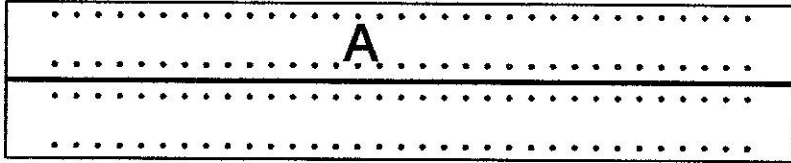

PARTS IDENTIFICATION

NOTE: FIRST MAKE SURE THAT YOU HAVE ALL OF THE PARTS LISTED ON THIS SHEET. IF YOU ARE MISSING ANY PIECE(S), DO NOT ASSEMBLE THE UNIT. INSTEAD, CALL OUR CUSTOMER SERVICE NUMBER AT: (888) 777-8250. WE WILL BE HAPPY TO ASSIST YOU.



2080A-Side	2pc	2080D-Bottom	1pcs
2080B-Center Divider	1pc	2080E-Base	1pcs
2080C-Top	1pc	2080F-Shelf	12pcs

PARTS ARE USUALLY MARKED ON THE RAW EDGE.

HARDWARE	PART #	DESCRIPTION	QTY
	BPXX54	SHELF SUPPORT	48
	DOWW525	WOOD DOWEL	24
	SPB1016BL	SMALL SCREW	8
	SWIGSQ	SWIVEL	1
	GLUEWD	GLUE	1

TOOL REQUIRED



PHILLIPS SCREWDRIVER

1

Apply one drop of glue into the six holes in each end of both side panels, (A). Then, tap the wood dowels into the holes as far as they can go. They should not stick out no more than 3/8" (little less than the thickness of the top and bottom). Afterwards, apply one drop of glue in each hole in the top (C) and install sides (A) onto it. Make sure the holes on the sides are facing each other and you leave no gap between connecting parts.

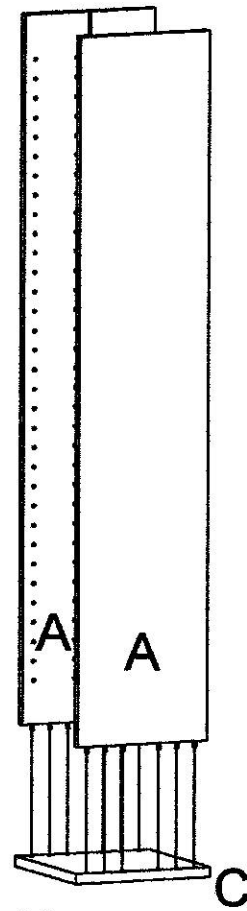
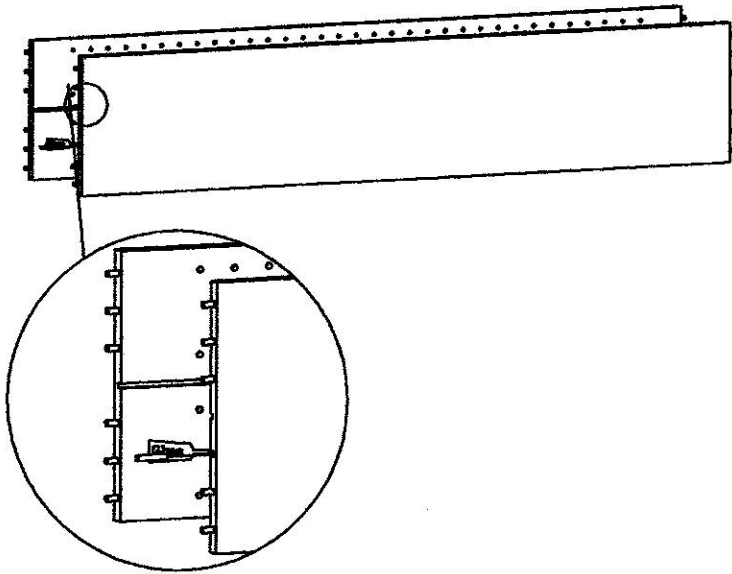
**2**

Then, slide the divider (B) between the two side panels, into their grooves as illustrated. Next, apply one drop of glue in each hole in the bottom (D) and connect it onto the assembly like shown to the right. Make sure again you press parts together leaving no gap between them as once glue has set you will not be able to undo this step.

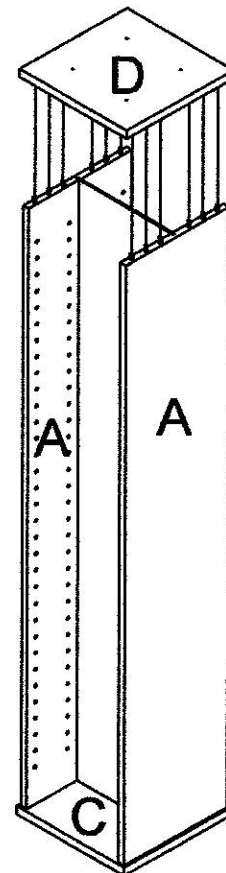

3

Now, using four small screws, screw the swivel onto the base, (PART E), as illustrated in this drawing. Make sure that you screw through the four holes indicated in the drawing.

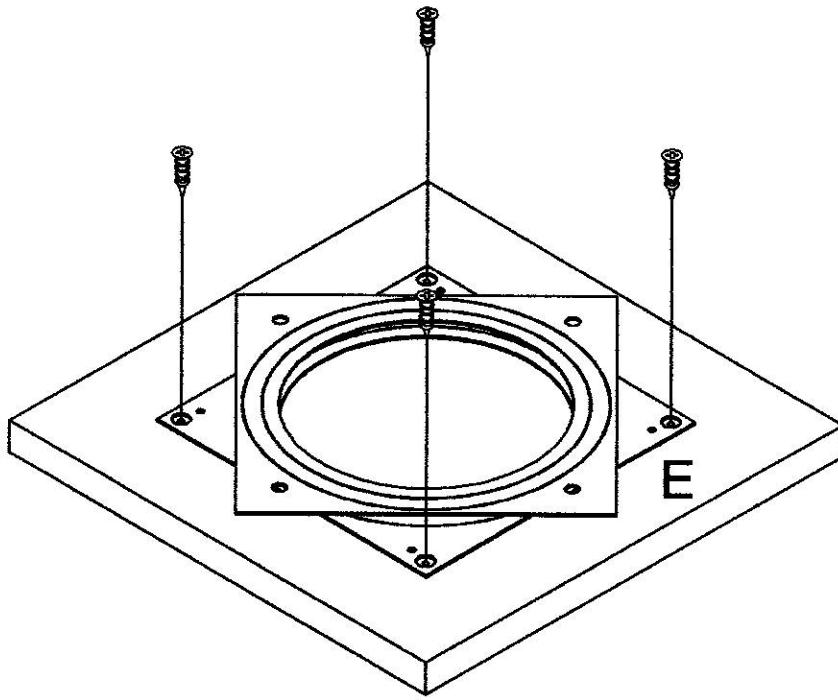
**4**

Place the unit on the floor so that the bottom, (PART D), faces upward. Then, place the base, (PART E), on the top of the unit, as shown. Using four small screws, attach the base onto the bottom piece. You will need to use the big hole, that is cut into the base, so that you can get to the four holes on the swivel. These four holes that you will need to screw through are indicated on the drawing below. NOTE: use a screwdriver with a magnetic head, or put some glue on the head of the screwdriver to keep the screws from falling off of the screwdriver.

You need to screw through these four holes.

